

GH36003M

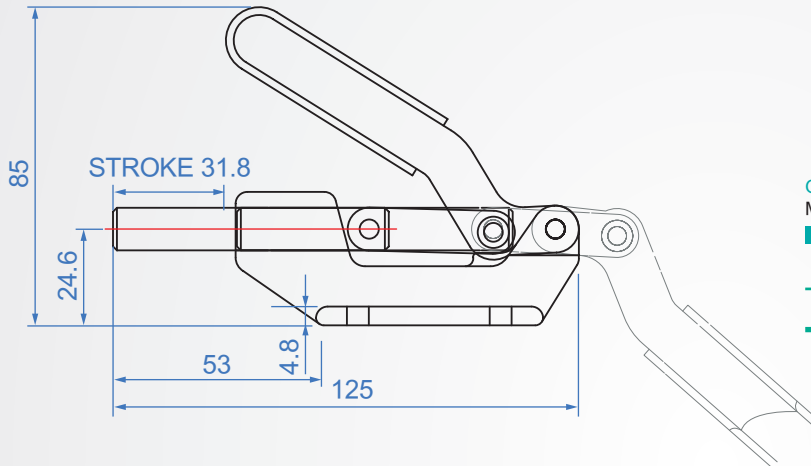
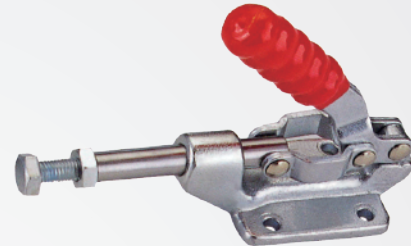
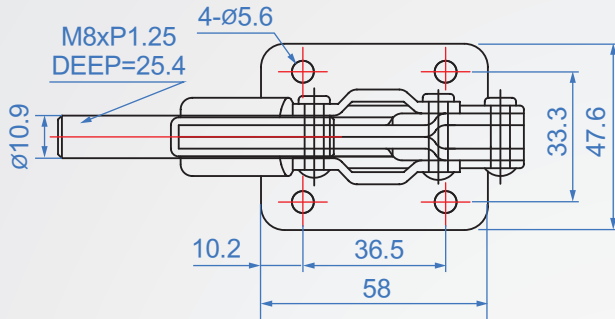

GH36003M

Material : SS400 Finish : Zinc plated

Unit : mm

Code No.	Clamping force(kg)	weight (g)	Hadle moving	Chuck moving	Front-end accessories
GH36003M	272	383	180°	31.8	NSA-085012