

GH25382

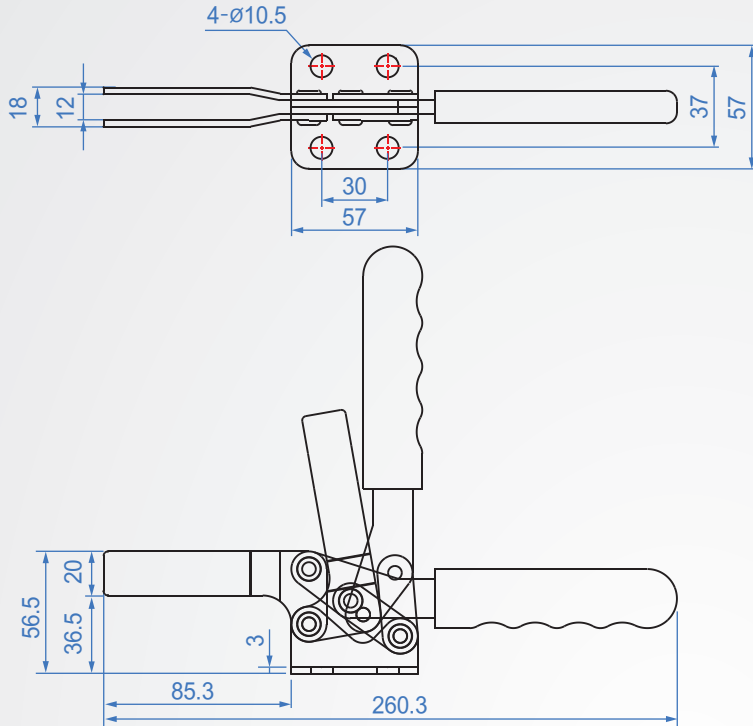

GH25382

Material : SS400 Finish : chromium plated

Unit : mm

Code No.	Clamping force(kg)	weight (g)	Hadle moving	Chuck moving	Front-end accessories
GH25382	280	455	87°	79°	NSA-086512