

Pitch : 5.0mm

5GT

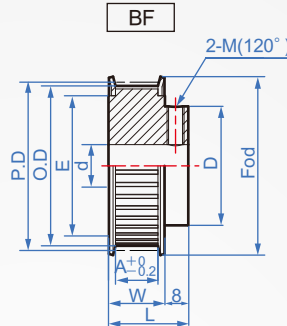
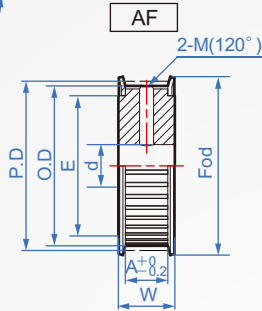
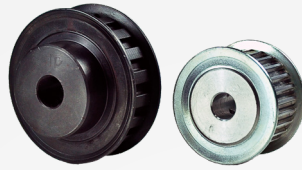
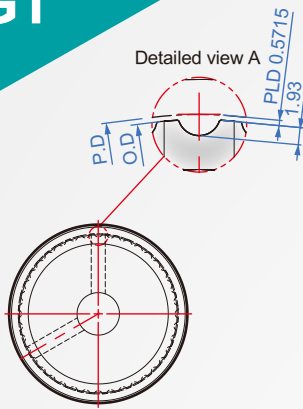

Belt width	9	15	20	25	30	40
Common size	A=10.3 W=14 L=22	A=16.3 W=20 L=28	A=21.3 W=25 L=33	A=26.3 W=30 L=38	A=31.3 W=35 L=43	A=41.3 W=45 L=53

How to order

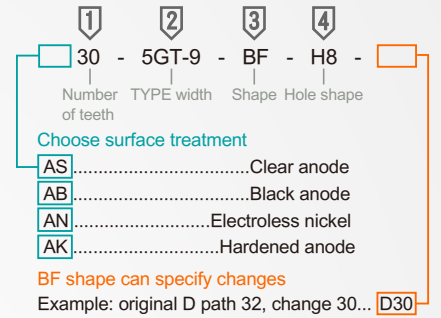

Material: Aluminum A6061+ anodized.
Please contact us if you need iron material.

Unit : mm											
1	2	3	4	Aperture d Processing min.	P.D	O.D	Number of teeth	D	E	Fod	
14				5~	22.28	21.14	14	12	16	26	
15			23.87		22.73	15	13	17	27		
16			25.46		24.32	16	15	18	28		
17			27.06		25.91	17	16	21	32		
18			28.65		27.5	18	18				
19			30.24		29.1	19	19	23.5	33.5		
20			31.83		30.69	20	20	24	35		
21			33.42		32.28	21	22	26	36		
22			35.01		33.87	22					
23			36.61		35.46	23	24	30	39		
24			38.2		37.05	24	26	30	42		
25			39.79		38.65	25	28	32.5	43.5		
26			41.38		40.24	26					
27			42.97		41.83	27	30	34	47		
28	5GT-9		44.56		43.42	28					
29			46.15		45.01	29	32	39	51		
30	5GT-15		47.75		46.6	30					
31			49.34		48.2	31	34	40	52		
32	5GT-20		50.93		49.79	32					
33			52.52	51.38	33	36	44	56			
34	5GT-25	AF	54.11	52.97	34						
35			55.7	54.56	35	38	46	58			
36	5GT-30	BF	57.3	56.16	36						
37			58.89	57.74	37	40	49	61			
38	5GT-40		60.48	59.34	38						
39			62.07	60.93	39	42	54	66			
40			63.66	62.52	40						
41			65.25	64.11	41	44	58	71			
42			66.85	65.7	42						
43			68.44	67.29	43	46	59	73			
44			70.03	68.89	44						
45			71.62	70.48	45	48	62.5	77.5			
46			73.21	72.07	46						
47			74.8	73.66	47	46	65	83			
48			76.39	75.25	48						
49			77.99	76.84	49	75	80	100			
50			79.58	78.43	50						
60			95.49	94.35	60	80	98	118			
70			111.41	110.27	70						
72			114.59	113.45	72	90	110	135			
80			127.32	126.18	80						
90			143.24	142.1	90	100	120	146			
100			159.15	158.01	100						

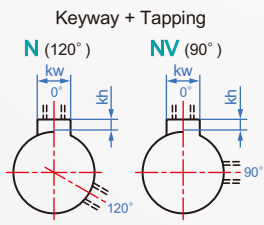
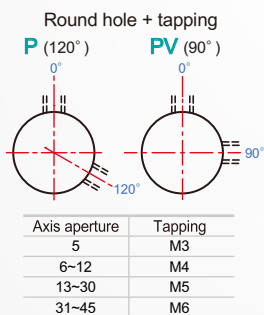
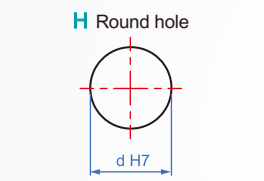

Shaft bore	kw(Js9)	kh	Tapping
8-10	3	1.4	M4
NK10	4	1.8	
11-12	4	2.3	
13-17	5	2.8	M5
18-22	6	3.3	
23-30	8	3.3	

Copyright © CHENA INDUSTRIAL CO.,LTD ALL RIGHTS RESERVED.