

GH36070

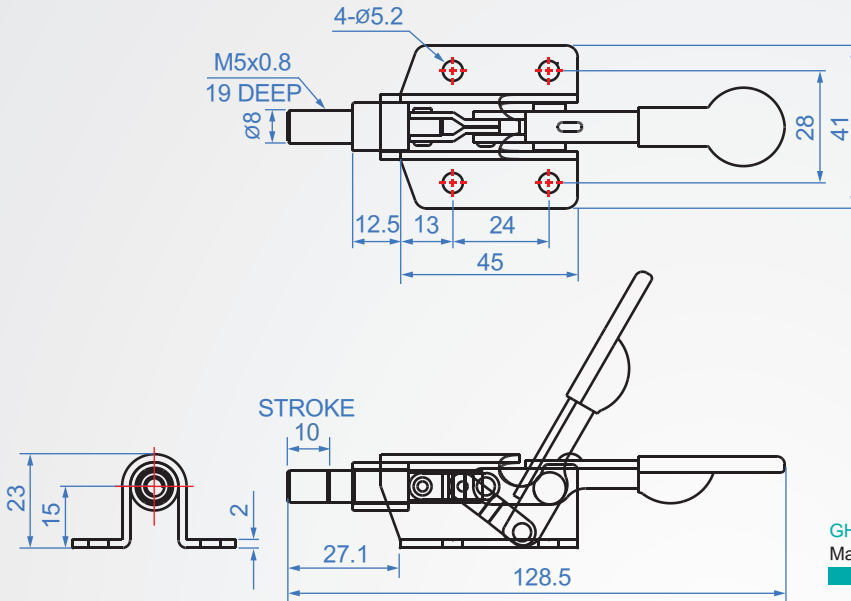

GH36070

Material : SS400 Finish : Chrome plated

unit : mm

Code No.	Clamping force(kg)	weight(g)	Hadle moving	Chuck moving	Front-end accessories
GH36070	50	95	66°	10	NSA-051508