

GH30619-M

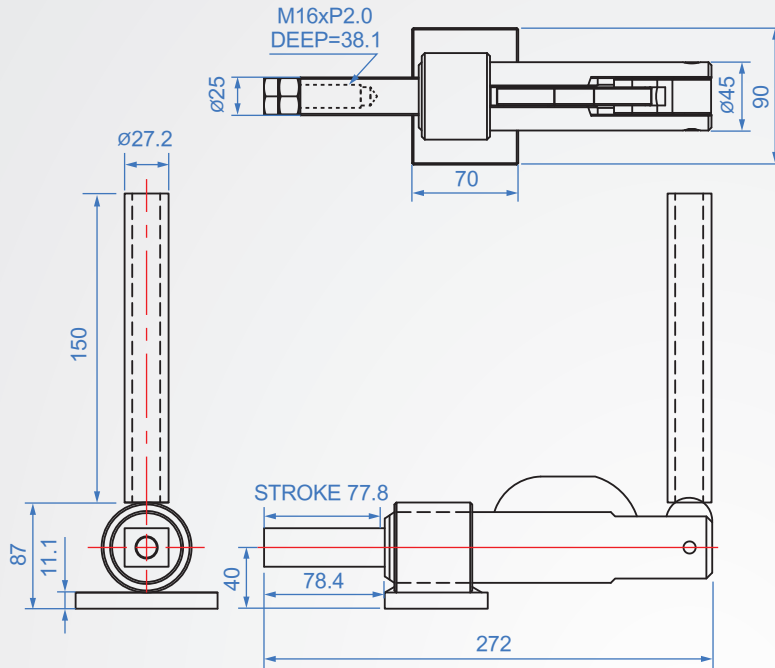

GH30619-M

Material : SS400 Finish : Zinc plated

Unit : mm

Code No.	Clamping force(kg)	weight (g)	Hadle moving	Chuck moving	Front-end accessories
GH30619-M	2273	3600	183°	77.8	NSA-165020