

GH12132

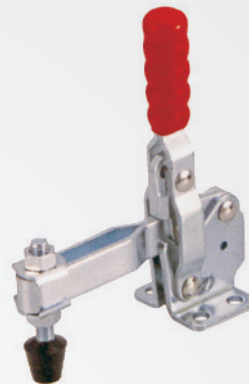
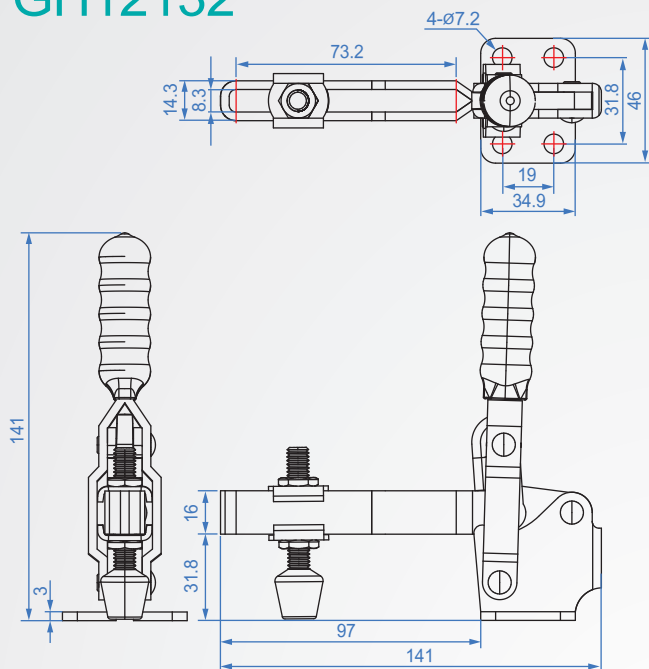

GH12132

材質：SS400 表面處理：鍍鋅

單位：mm

Code No.	夾壓力(kg)	重量(g)	把手移動	夾頭移動	前端配件
GH12132	227	370	56°	100°	NFC-56212