

GH14412

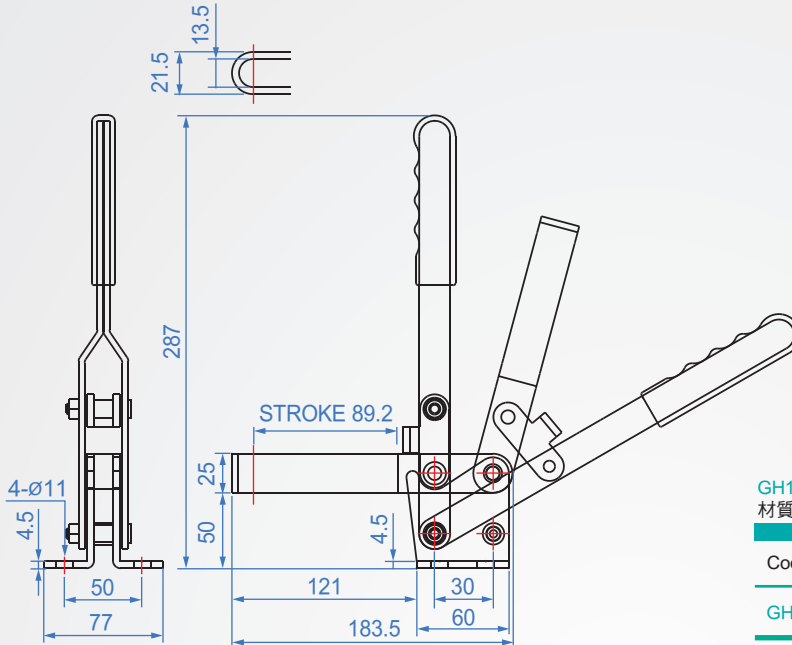

GH14412

材質：SS400 表面處理：鍍鉻

單位：mm

Code No.	夾壓力(kg)	重量(g)	把手移動	夾頭移動	前端配件
GH14412	300	1270	74°	140°	NSA-109015