

GH13005-SM

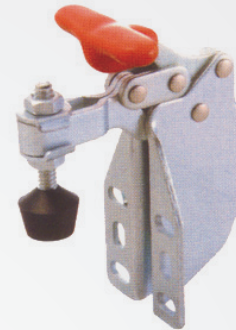
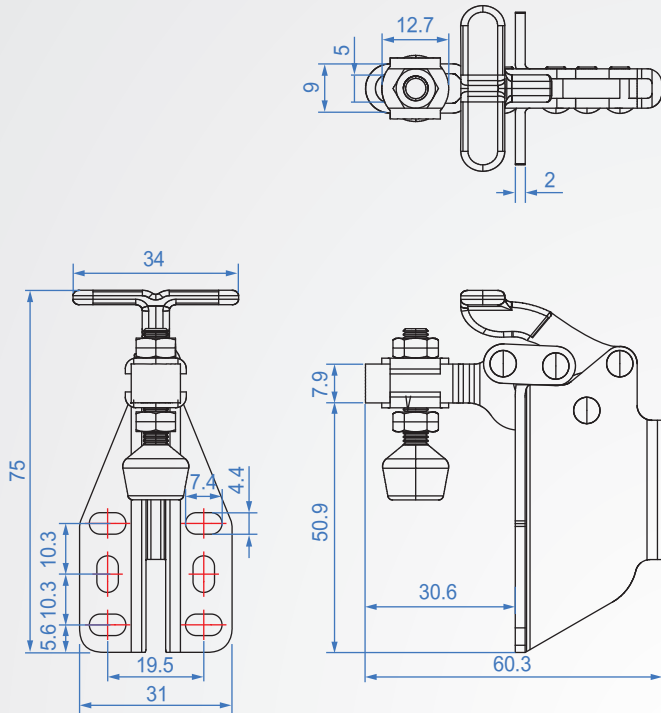

GH13005-SM

Material : SS400 Finish : Zinc plated

unit : mm

Code No.	Clamping pressure (kg)	weight (g)	Handle movement	Chuck movement	Front end fitting
GH13005-SM	68	92	170°	90°	NFC-10138