

GH20300

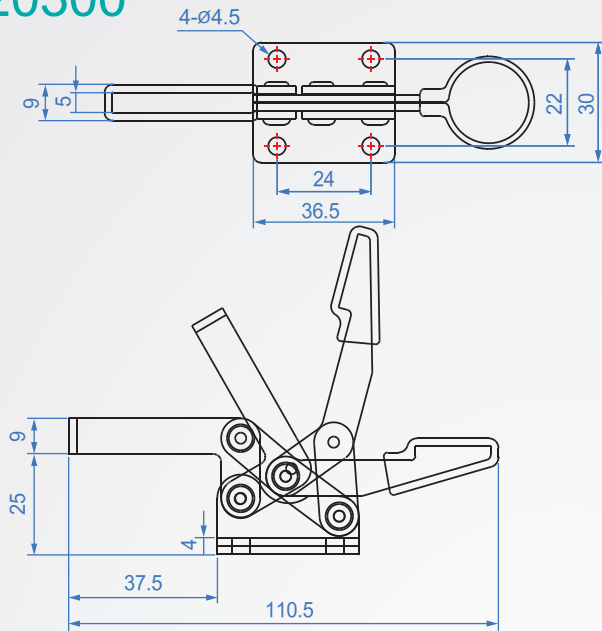

GH20300

材質：SS400 表面處理：鍍鉻

單位：mm

Code No.	夾壓力(kg)	重量(g)	把手移動	夾頭移動	前端配件
GH20300	30	102	74°	72°	NSA-044007

1N=0.102kgf