

GH20100

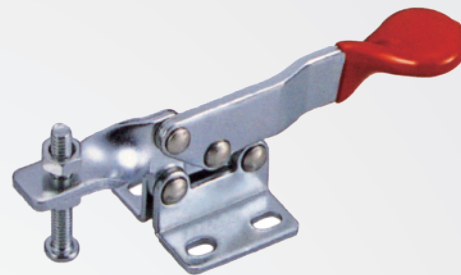
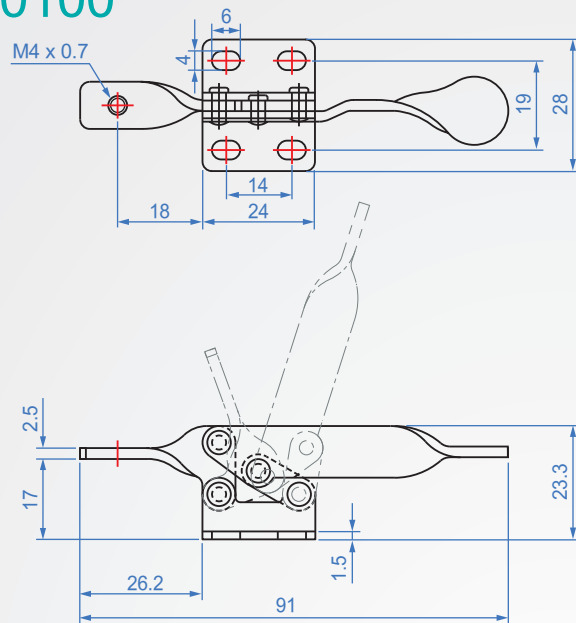

GH20100

材質：SS400 表面處理：鍍鋅

單位：mm

Code No.	夾壓力(kg)	重量(g)	把手移動	夾頭移動	前端配件
GH20100	20	40	72°	71°	NSA-042507