

GH20100

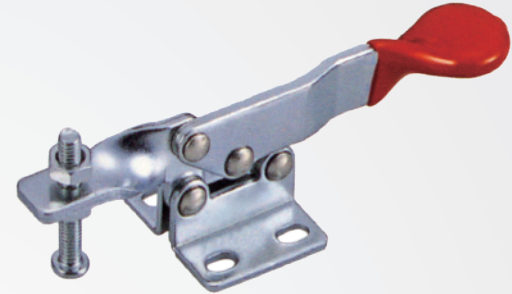
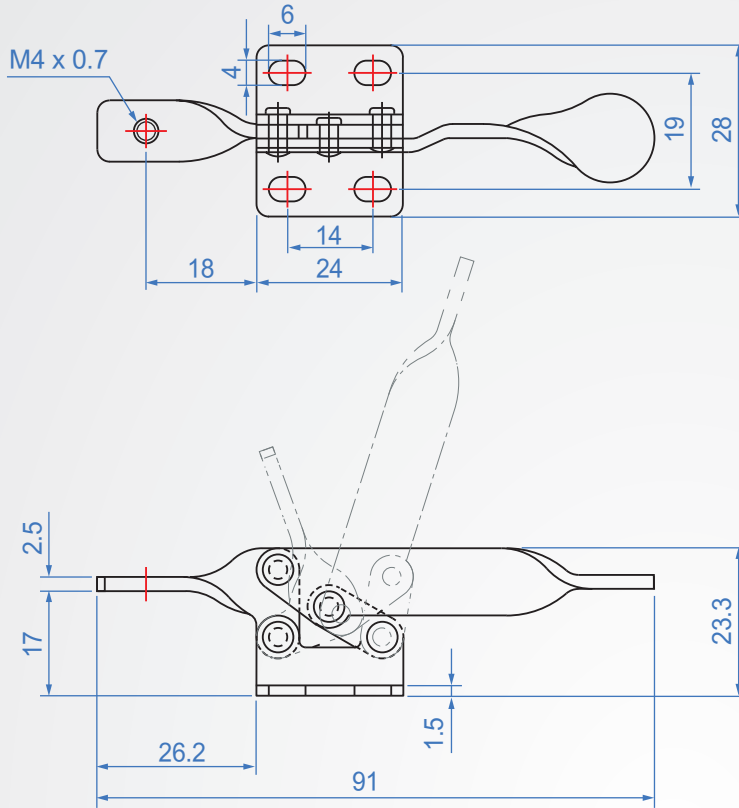

GH20100

Material : SS400 Finish : Zinc plated

unit : mm

Code No.	Clamping pressure (kg)	weight (g)	Handle movement	Chuck movement	Front end fitting
GH20100	20	40	72°	71°	NSA-042507